

- SA 系列 IP67
- SA Series IP67
- 推入式快速锁紧
- Push-pull coupling

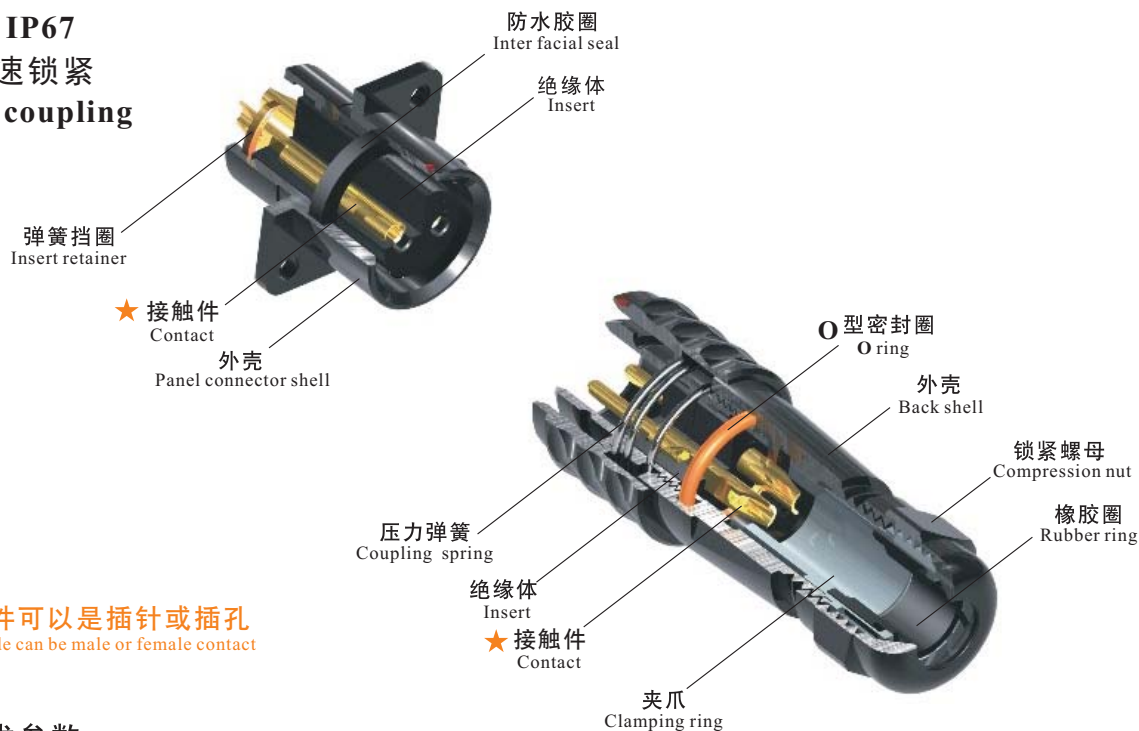

★ 接触件可以是插针或插孔
Each side can be male or female contact

材料和技术参数 Material and spec

接插方式	Coupling	推入式快速锁紧	Push-pull
外壳材料	Shell material	铝阳极氧化	Anodized aluminium
绝缘体	Insert material	热塑性塑料PPS 耐高温 260℃	PPS, max temperature 260 °C
接触件材料	Contact material	铜镀金	Brass with gold plating
接线方式	Termination	焊接: SA6, SA8, SA10, SA12, SA16, SA20, SA24, SA28 压接: SA16, SA20, SA24, SA28 螺丝压接: SA20, SA24, SA28	Solder: SA6, SA8, SA10, SA12, SA16, SA20, SA24, SA28 Crimp: SA16, SA20, SA24, SA28 Screw: SA20, SA24, SA28
电缆直径	Cable outer diameter range	SA6: I:2-3mm, II:3-4mm (不标) SA8: I:3-4mm, II:4-5mm (不标) SA10: I:3-4mm, II:4-6.5mm (不标)	SA12: I:4-6.5mm (不标), II:5-8mm SA16: I:5-8mm (不标), II:8-12mm SA20: I:5-9mm, II:8-12mm (不标) SA24:10-14mm SA28: I:9-13mm, II:13-16mm (不标)
防护等级	IP rating	IP67	
接插次数	Mating cycle	500	
温度范围	Temperature range	-40℃ ~+85℃; 信号、数据: -20℃ ~+70℃	
绝缘电阻	Insulation resistance	2000 MΩ	

SA6 Series



电缆插头
与SA611、SA612、SA615相配

Cable connector
Mate with SA611, SA612,
SA615

颜色: Colour:
B:黑色 B: Black
S:银色 S: Silver
L:蓝色 (订做) L: Blue (special order)
G:绿色 (订做) G: Green (special order)
R:红色 (订做) R: Red (special order)

电缆直径: Cable outer diameter range
I: 2-3mm, II: 3-4mm (不标)
芯数 Number of contact
插孔 Female contact

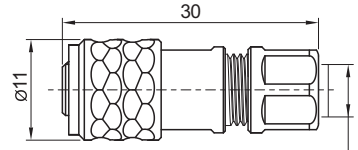
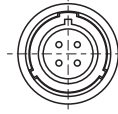

电缆直径: I: 2-3mm, II: 3-4mm (不标)
Cable outer diameter range

SA610 / P _____ SA610 / S _____
插针 Male contact



电缆对接插座
与SA610相配

In-line cable connector
Mate with SA610

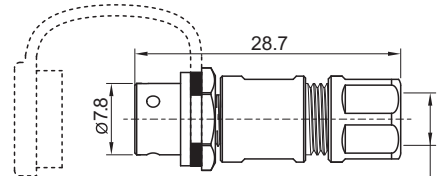

电缆直径: I: 2-3mm, II: 3-4mm (不标)
Cable outer diameter range

SA611 / P _____ SA611 / S _____



后螺母插座
与SA610相配

Rear-nut mount
Mate with SA610

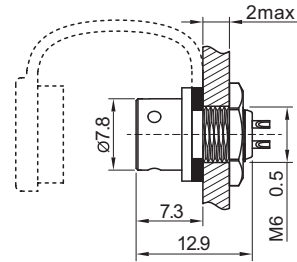

开孔尺寸
Panel cutout

SA612 / P _____ SA612 / S _____



前螺母插座
与SA610相配

Front-nut mount
Mate with SA610

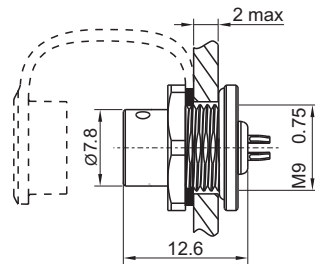

开孔尺寸
Panel cutout

SA615 / P _____ SA615 / S _____

焊接芯件参数 Solder contact spec

芯数 Number of contact	2	3	4	5
公端绝缘体正面图 Male contact face view				
额定电流 (A) Rated current (A)	3	3	3	3
接触件直径(mm) Contact diameter(mm)	∅0.6 2	∅0.6 3	∅0.6 4	∅0.6 5
工作电压 (AC.V) Rated voltage (AC.V)	30	30	30	30
耐压 (AC.V) 1 min Test voltage(AC.V) 1 min	500	500	500	500
接触电阻 (mΩ) Contact resistance (mΩ)	10	10	10	10
线规 (mm ² /AWG) Wire size (mm ² /AWG)	≤0.5/20	≤0.5/20	≤0.5/20	≤0.5/20

SA8 Series

03



SA810/P — SA810/S
插针 Male contact

电缆插头
与SA811、SA812、SA815相配

Cable connector
Mate with SA811, SA812,
SA815

颜色: Colour:
B:黑色 B: Black
S:银色 S: Silver
L:蓝色 (订做) L: Blue (special order)
G:绿色 (订做) G: Green (special order)
R:红色 (订做) R: Red (special order)

电缆直径: Cable outer diameter range
I: 3-4mm, II: 4-5mm (不标)

芯数 Number of contact
插孔 Female contact

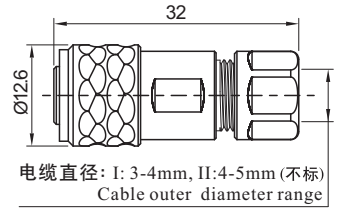
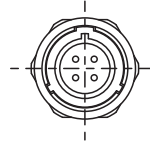

电缆直径: I: 3-4mm, II: 4-5mm (不标)
Cable outer diameter range



SA811/P — SA811/S

电缆对接插座
与SA810相配

In-line cable connector
Mate with SA810

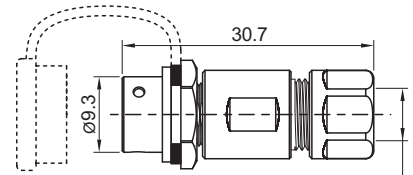

电缆直径: I: 3-4mm, II: 4-5mm (不标)
Cable outer diameter range



SA812/P — SA812/S

后螺母插座
与SA810相配

Rear-nut mount
Mate with SA810

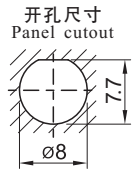
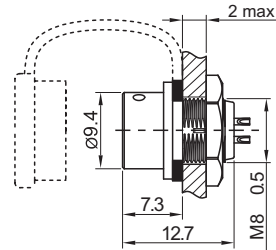
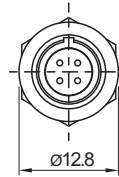

开孔尺寸
Panel cutout



SA815/P — SA815/S

前螺母插座
与SA810相配

Front-nut mount
Mate with SA810

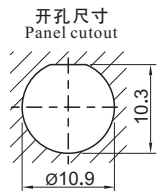
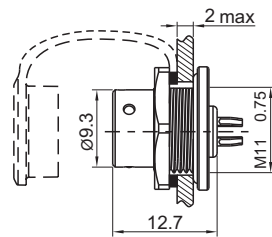
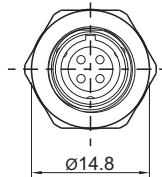

开孔尺寸
Panel cutout

焊接芯件参数 Solder contact spec

芯数 Number of contact	2	3	4	6	8
公端绝缘体正面图 Male contact face view					
额定电流 (A) Rated current (A)	5	5	3	3	3
接触件直径(mm) Contact diameter(mm)	Ø1×2	Ø1×3	Ø0.6×4	Ø0.6×6	Ø0.6×8
工作电压 (AC.V) Rated voltage (AC.V)	125	125	30	30	30
耐压 (AC.V) 1 min Test voltage(AC.V) 1 min	1000	1000	500	500	500
接触电阻 (mΩ) Contact resistance (mΩ)	5	5	10	10	10
线规 (mm²/AWG) Wire size (mm²/AWG)	≤0.75/18	≤0.75/18	≤0.5/20	≤0.5/20	≤0.5/20

SA10 Series



SA1010/P SA1010/S
插针 Male contact

电缆插头

与SA1011、SA1012、SA1015相配

Cable connector
Mate with SA1011, SA1012,
SA1015

颜色: Colour:
B:黑色 B: Black
S:银色 S: Silver
L:蓝色 (订做) L: Blue (special order)
G:绿色 (订做) G: Green (special order)
R:红色 (订做) R: Red (special order)

电缆直径: Cable outer diameter range
I: 3-4mm, II: 4-6.5mm (不标)

芯数 Number of contact
插孔 Female contact

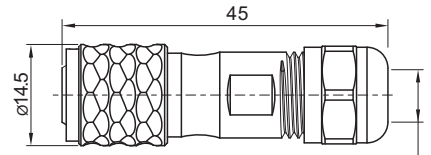
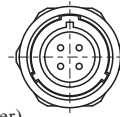

电缆直径: I: 3-4mm, II: 4-6.5mm (不标)
Cable outer diameter range



SA1011/P SA1011/S

电缆对接插座

与SA1010相配

In-line cable connector
Mate with SA1010

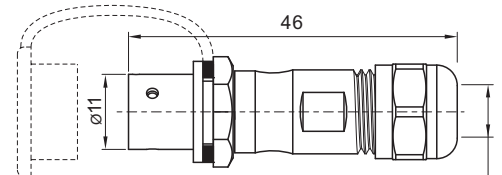
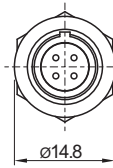

电缆直径: I: 3-4mm, II: 4-6.5mm (不标)
Cable outer diameter range



SA1012/P SA1012/S

后螺母插座

与SA1010相配

Rear-nut mount
Mate with SA1010

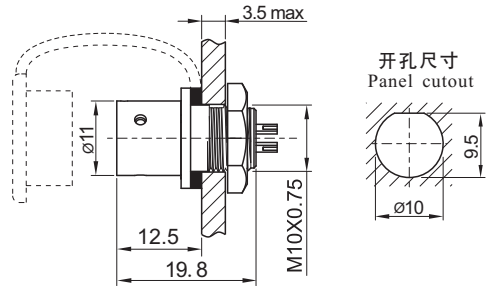
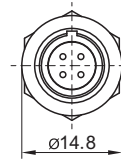

开孔尺寸
Panel cutout



SA1015/P SA1015/S

前螺母插座

与SA1010相配

Front-nut mount
Mate with SA1010

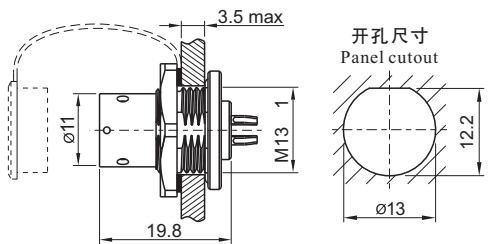
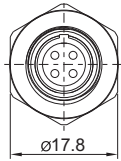

开孔尺寸
Panel cutout

焊接芯件参数 Solder contact spec

芯数 Number of contact	2	3	4	5
公端绝缘体正面图 Male contact face view				
额定电流 (A) Rated current (A)	5	5	3	3
接触件直径(mm) Contact diameter(mm)	Ø1×2	Ø1×3	Ø0.7×4	Ø0.7×5
工作电压 (AC.V) Rated voltage (AC.V)	180	180	125	125
耐压 (AC.V) 1 min Test voltage(AC.V) 1 min	1000	1000	1000	1000
接触电阻 (mΩ) Contact resistance(mΩ)	5	5	10	10
线规 (mm²/AWG) Wire size (mm²/AWG)	≤0.75/18	≤0.75/18	≤0.5/20	≤0.5/20

SA12 Series

SA
12

03



电缆插头
与SA1211、SA1212、SA1213、SA1215相配
Cable connector
Mate with SA1211, SA1212
SA1213, SA1215

SA1210/P — SA1210/S
插针 Male contact
插孔 Female contact
芯数 Number of contact

颜色: Colour:
B:黑色 B: Black
S:银色 S: Silver
L:蓝色 (订做) L: Blue (special order)
G:绿色 (订做) G: Green (special order)
R:红色 (订做) R: Red (special order)
电缆直径 Cable outer diameter
I : 4-6.5mm(不标), II : 5-8mm

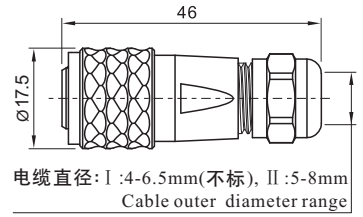
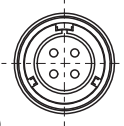

电缆对接插座
与SA1210相配
In-line cable connector
Mate with SA1210

SA1211/P — SA1211/S

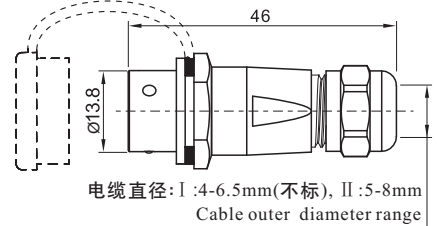
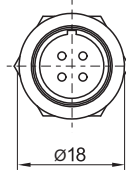

后螺母插座
与SA1210相配
Rear-nut mount
Mate with SA1210

SA1212/P — SA1212/S
芯数 Number of contact

颜色: Colour:
B:黑色 B: Black
S:银色 S: Silver
L:蓝色 (订做) L: Blue (special order)
G:绿色 (订做) G: Green (special order)
R:红色 (订做) R: Red (special order)

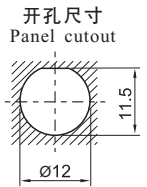
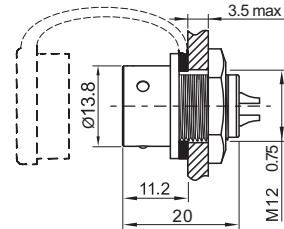
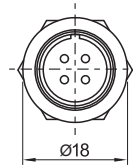

方形法兰插座
与SA1210相配
Square flange
Mate with SA1210

SA1213/P — SA1213/S

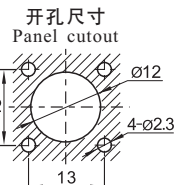
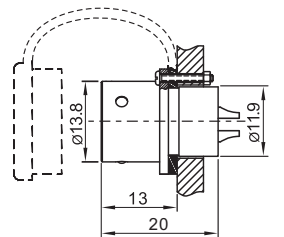
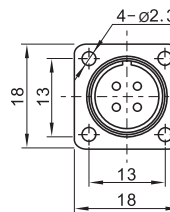

前螺母插座
与SA1210相配
Front-nut mount
Mate with SA1210

SA1215/P — SA1215/S

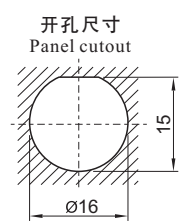
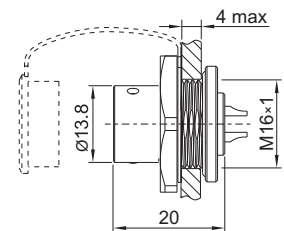
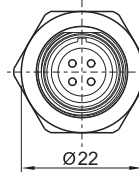

焊接芯件参数 Solder contact spec

芯数 Number of contact	2	3	4	5	6	7	9
公端绝缘体正面图 Male contact face view							
额定电流(A) Rated current (A)	13	13	5	5	5	5	3
接触件直径(mm) Contact diameter	ø1.6X2	ø1.6X3	ø1X4	ø1X5	ø1X6	ø1X7	ø0.7X9
工作电压(AC.V) Rated voltage (AC.V)	250	250	200	180	125	125	125
耐压(AC.V) 1 min Test voltage(AC.V) 1 min	1500	1500	1500	1000	1000	1000	1000
接触电阻(mΩ) Contact resistance (mΩ)	2.5	2.5	5	5	5	5	10
线规(mm²/AWG) Wire size (mm²/AWG)	≤2/14	≤2/14	≤0.75/18	≤0.75/18	≤0.75/18	≤0.75/18	≤0.5/20

SA16 Series

**SA
16**



电缆插头
与SA1611、SA1612、SA1613、SA1615相配

Cable connector
Mate with SA1611, SA1612,
SA1613, SA1615

1: 焊接(不标), 3: 压接
1: solder, 3: crimp

颜色: Colour:
B: 黑色 B: Black
S: 银色 S: Silver
L: 蓝色(订做) L: Blue (special order)
G: 绿色(订做) G: Green (special order)
R: 红色(订做) R: Red (special order)

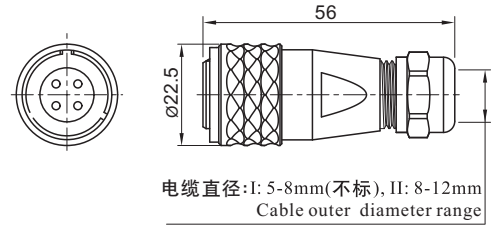

电缆直径: I: 5-8mm(不标), II: 8-12mm
Cable outer diameter range

SA1610/P 插针 Male contact
SA1610/S 插孔 Female contact
芯数 Number of contact
电缆直径 Cable outer diameter
I: 5-8mm(不标), II: 8-12mm



电缆对接插座
与SA1610相配
In-line cable connector
Mate with SA1610

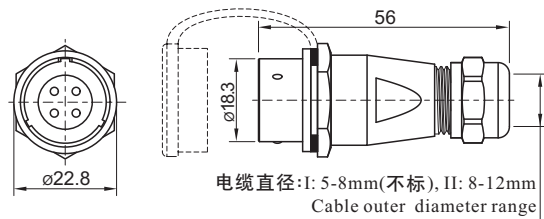

电缆直径: I: 5-8mm(不标), II: 8-12mm
Cable outer diameter range

SA1611/P SA1611/S



后螺母插座
与SA1610相配
Rear-nut mount
Mate with SA1610

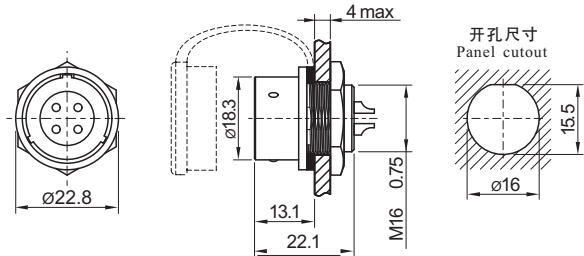

1: 焊接(不标), 3: 压接
1: solder, 3: crimp
颜色 Colour

SA1612/P SA1612/S
芯数 Number of contact



方形法兰插座
与SA1610相配
Square flange
Mate with SA1610

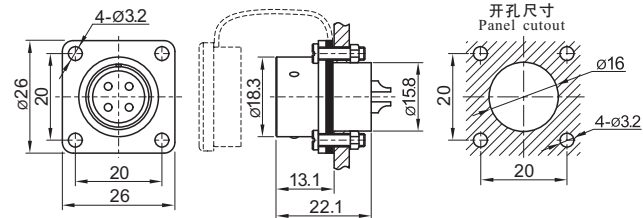

SA1613/P SA1613/S



前螺母插座
与SA1610相配
Front-nut mount
Mate with SA1610

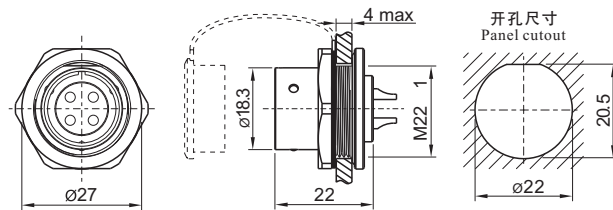

SA1615/P SA1615/S

焊接芯件参数 Solder contact spec

★压接芯件参数表在P20页>> Crimp contact spec see P20

芯数 Number of contact	2	3	4	2B	3B	4B	5	7	9	10
公端绝缘体正面图 Male contact face view										
额定电流(A) Rated current (A)	10	10	5	15	15	15	5	5	5	5
接触件直径(mm) Contact diameter(mm)	∅1.5X2	∅1.5X3	∅1X4	∅2X2	∅2X3	∅2X4	∅1X5	∅1X7	∅1X9	∅1X10
工作电压(AC.V) Rated voltage (AC.V)	500	500	500	500	500	500	500	400	400	400
耐压(AC.V) 1 min Test voltage(AC.V) 1 min	1500	1500	1500	1500	1500	1500	1500	1200	1200	1200
接触电阻 (mΩ) Contact resistance(mΩ)	2.5	2.5	5	2.5	2.5	2.5	5	5	5	5
线规 (mm ² /AWG) Wire size (mm ² /AWG)	≤2/14	≤2/14	≤0.75/18	≤2/14	≤2/14	≤2/14	≤0.75/18	≤0.75/18	≤0.75/18	≤0.75/18

SA20 Series

SA
20



电缆插头
与SA2011、SA2012、SA2013、SA2015相配
Cable connector
Mate with SA2011, SA2012, SA2013, SA2015

SA2010/P --- SA2010/S
插针 Male contact
插孔 Female contact
芯数 Number of contact

1: 焊接(不标), 2: 螺丝压接, 3: 压接
1: solder, 2: screw, 3: crimp

颜色: Colour:
B: 黑色 B: Black
S: 银色 S: Silver
L: 蓝色(订做) L: Blue (special order)
G: 绿色(订做) G: Green (special order)
R: 红色(订做) R: Red (special order)

电缆直径: Cable outer diameter range
I: 5-9mm, II: 8-12mm(不标)

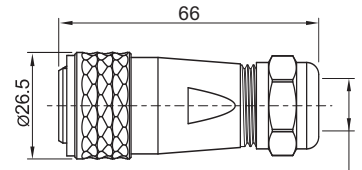
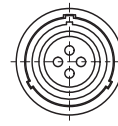

电缆直径: I: 5-9mm, II: 8-12mm(不标)
Cable outer diameter range



电缆对接插座
与SA2010相配
In-line cable connector
Mate with SF2010

SA2011/P --- SA2011/S

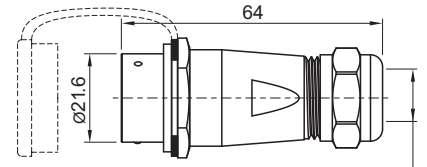

电缆直径: I: 5-9mm, II: 8-12mm(不标)
Cable outer diameter range



后螺母插座
与SA2010相配
Rear-nut mount
Mate with SA2010

SA2012/P --- SA2012/S

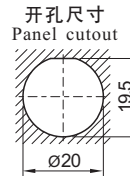
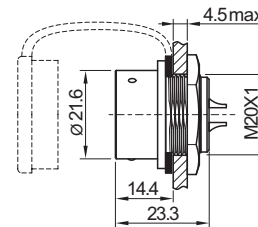

方方法兰插座
与SA2010相配
Square flange
Mate with SA2010

SA2013/P --- SA2013/S

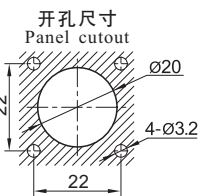
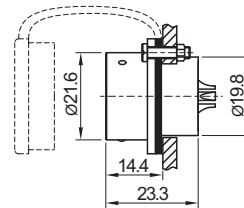
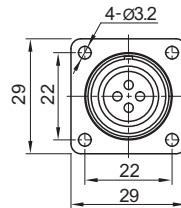

前螺母插座
与SA2010相配
Front-nut mount
Mate with SA2010

SA2015/P --- SA2015/S

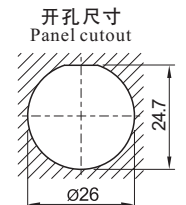
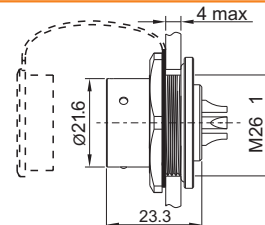
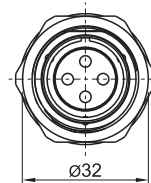

焊接芯件参数 Solder contact spec

★压接芯件参数表在P20页>>
Crimp contact spec see P20

★螺丝压接芯件参数表在P21页>>
Screw contact spec see P21

芯数 Number of contact	2	3	4	5	6	6B	7	8	9	12	15
公端绝缘体正面图 Male contact face view											
额定电流(A) Rated current (A)	25	25	25	10	25 5	30 5	10	10	5	5	5
接触件直径(mm) Contact diameter(mm)	Ø2.5X2	Ø2.5X3	Ø2.5X4	Ø1.5X5	Ø2.5X4 Ø1X2	Ø3X2 Ø1X4	Ø1.5X7	Ø1.5X8	Ø1X9	Ø1X12	Ø1X15
工作电压(AC.V) Rated voltage (AC.V)	500	500	500	500	500	500	500	500	400	400	400
耐压(AC.V) 1 min Test voltage(AC.V) 1 min	1500	1500	1500	1500	1500	1500	1500	1500	1200	1200	1200
接触电阻(mΩ) Contact resistance (mΩ)	1	1	1	2.5	1 5	1 5	2.5	2.5	5	5	5
接线方式 Termination	焊接/螺丝压接 solder / screw	焊接/螺丝压接 solder / screw	焊接/螺丝压接 solder / screw	焊接 solder	焊接 solder	焊接 solder	焊接 solder	焊接 solder	焊接 solder	焊接 solder	焊接 solder
焊接线规(mm ² /AWG) Wire size for solder (mm ² / AWG)	≤4/11	≤4/11	≤4/11	≤2/14	≤4/11 ≤0.75/18	≤4/11 ≤0.75/18	≤2/14	≤2/14	≤0.75/18	≤0.75/18	≤0.75/18
螺丝压接线规(mm ² /AWG) Wire size for screw termination (mm ² /AWG)	≤1.5/15	≤1.5/15	≤1.5/15	/	/	/	/	/	/	/	/

SA24 Series

SA
24



电缆插头
与SA2411、SA2412、SA2413相配

Cable connector
Mate with SA2411, SA2412, SA2413

SA2410/P — SA2410/S
插针 Male contact
插孔 Female contact
芯数 Number of contact

1: 焊接(不标), 2: 螺丝压接, 3: 压接
1: solder, 2: screw, 3: crimp

颜色: Colour:
B: 黑色 B: Black
S: 银色 S: Silver
L: 蓝色(订做) L: Blue (special order)
G: 绿色(订做) G: Green (special order)
R: 红色(订做) R: Red (special order)

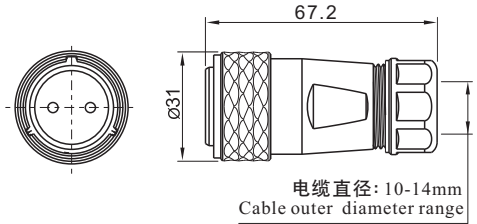

电缆直径: 10-14mm
Cable outer diameter range



电缆对接插座
与SA2410相配

In-line cable connector
Mate with SA2410

SA2411/P — SA2411/S

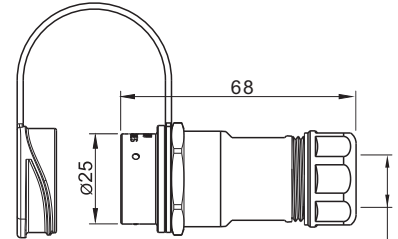

电缆直径: 10-14mm
Cable outer diameter range



后螺母插座
与SA2410相配

Rear-nut mount
Mate with SA2410

SA2412/P — SA2412/S

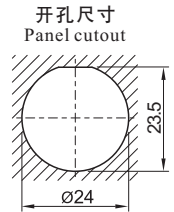
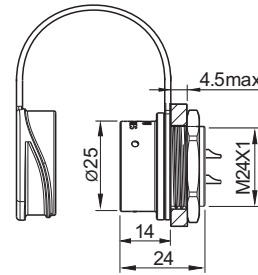

开孔尺寸
Panel cutout



方方法兰插座
与SA2410相配

Square flange
Mate with SA2410

SA2413/P — SA2413/S

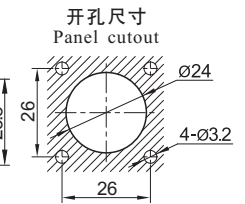
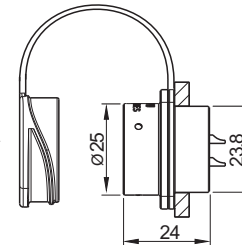
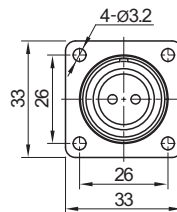

开孔尺寸
Panel cutout

焊接芯件参数 Solder contact spec

★压接芯件参数表在P20页>>
Crimp contact spec see P20

★螺丝压接芯件参数表在P21页>>
Screw contact spec see P21

WS24、WF24、WY24	2	3	4	9	10	12	12B	19
公端绝缘体正面图 Male contact face view								
额定电流(A) Rated current(A)	25	25	25	5 25	10	10	5 30	5
接触件直径(mm) Contact diameter(mm)	Ø2.5X2	Ø2.5X3	Ø2.5X4	Ø1X5 Ø2.5X4	Ø1.5X10	Ø1.5X12	Ø1X9 Ø3X3	Ø1X19
工作电压(AC.V) Rated voltage(AC.V)	500	500	500	500	500	500	500	400
耐压(AC.V) 1 min Test voltage(AC.V) 1 min	1500	1500	1500	1500	1500	1500	1500	1200
接触电阻(mΩ) Contact resistance(mΩ)	1	1	1	5 1	2.5	2.5	5 1	5
绝缘电阻(MΩ) Insulation resistance(MΩ)	2000	2000	2000	2000	2000	2000	2000	2000
线规(mm ² /AWG) Wire size(mm ² /AWG)	≤4/11	≤4/11	≤4/11	≤0.75/18 ≤4/11	≤2/14	≤2/14	≤0.75/18 ≤4/11	≤0.75/18
螺丝压接线规(mm ² /AWG) Wire size for screw termination	≤1.5/15	≤1.5/15	≤1.5/15	/	/	/	/	/

SA28 Series



03



电缆插头
与SA2811、SA2812、SA2813、SA2815相配
Cable connector
Mate with SA2811, SA2812, SA2813, SA2815

1: 焊接(不标), 2: 螺丝压接, 3: 压接
1: solder, 2: screw, 3: crimp

颜色: Colour:
B: 黑色 B: Black
S: 银色 S: Silver
L: 蓝色 (订做) L: Blue (special order)
G: 绿色 (订做) G: Green (special order)
R: 红色 (订做) R: Red (special order)

电缆直径: Cable outer diameter range
I: 9-13mm, II: 13-16mm(不标)

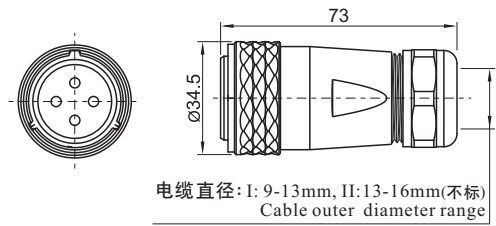

SA2810/P --- SA2810/S
插针 Male contact
插孔 Female contact
芯数 Number of contact



电缆对接插座
与SA2810相配
In-line cable connector
Mate with SA2810

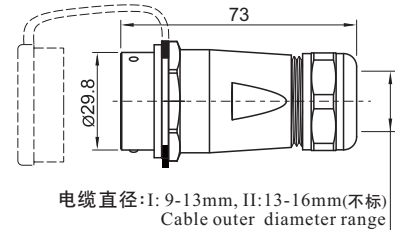
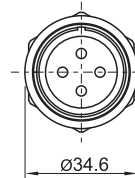

SA2811/P --- SA2811/S



后螺母插座
与SA2810相配
Rear-nut mount
Mate with SA2810

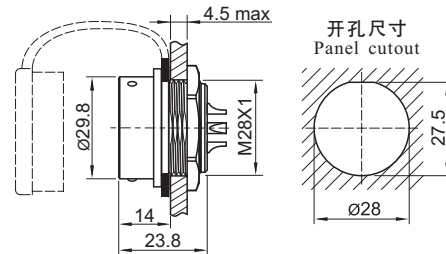
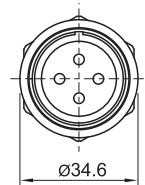

SA2812/P --- SA2812/S



方形法兰插座
与SA2810相配
Square flange
Mate with SA2810

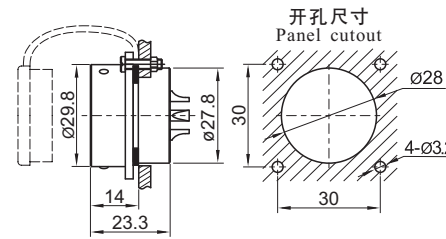
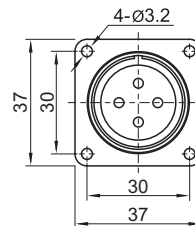

SA2813/P --- SA2813/S



前螺母插座
与SA2810相配
Front-nut mount
Mate with SA2810

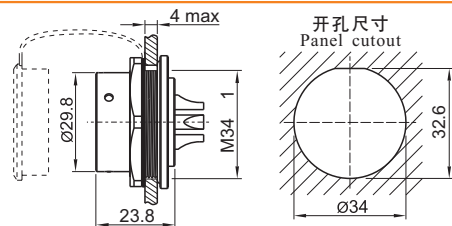
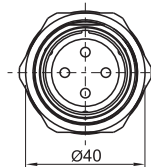

SA2815/P --- SA2815/S

焊接芯件参数 Solder contact spec

★ 压接芯件参数表在P20页>>
Crimp contact spec see P20

★ 螺丝压接芯件参数表在P21页
Screw contact spec see P21

芯数 Number of contact	2	3	4	7	8	8B	9	10	10B	12	16	17	20	24	26	35
公端绝缘体正面图 Male contact face view																
额定电流 (A) Rated current (A)	50	50	25	25	25	60.5	25.5	25	10	10	10	10	5	5	5	5
接触件直径(mm) Contact diameter(mm)	Ø3.5X2	Ø3.5X3	Ø2.5X4	Ø2.5X7	Ø2.5X8	Ø5X2 Ø1X6	Ø2.5X4 Ø1X5	Ø2.5X10	Ø1.5X10	Ø1.5X12	Ø1.5X16	Ø1.5X17	Ø1X20	Ø1X24	Ø1X26	Ø1X35
工作电压 (AC.V) Rated voltage (AC.V)	500	500	500	500	500	500 400	500	500	500	500	500	500	400	400	400	400
耐压 (AC.V) 1 min Test voltage(AC.V) 1 min	1500	1500	1500	1500	1500	1500	1500	1500	1500	1500	1500	1500	1200	1200	1200	1200
接触电阻 (mΩ) Contact resistance(mΩ)	0.5	0.5	1	1	1	0.5、5	1、5	1	2.5	2.5	2.5	2.5	5	5	5	5
接线方式 Termination	焊接/螺丝压接 solder / screw	焊接/螺丝压接 solder / screw	焊接/螺丝压接 solder / screw	焊接/螺丝压接 solder / screw	焊接/螺丝压接 solder / screw	焊接 solder	焊接 solder	焊接/螺丝压接 solder / screw	焊接 solder	焊接 solder	焊接 solder	焊接 solder	焊接 solder	焊接 solder	焊接 solder	焊接 solder
线规 (mm²/AWG) Wire size (mm²/AWG)	≤10/7	≤10/7	≤4/11	≤4/11	≤4/11	≤16/5 ≤0.75/18	≤4/11 ≤0.75/18	≤4/11	≤2/14	≤2/14	≤2/14	≤2/14	≤0.75/18	≤0.75/18	≤0.75/18	≤0.75/18
螺丝压接线规 (mm²/AWG) Wire size for screw termination	≤6/10	≤6/10	≤1.5/15	≤1.5/15	≤1.5/15	/	/	≤1.5/15	/	/	/	/	/	/	/	/

SA24 Series



SA24
信号数据



LC 光纤电缆插头
与 SA2411、SA2412、SA2413 相配
Plug with LC adapter
Mate with SA2411, SA2412, SA2413

SA2410/PLC

线长:	Wire length:
0.5m	0.5m
1.0m	1.0m
1.5m	1.5m
2.0m	2.0m
3.0m	3.0m

颜色:	Colour:
B: 黑色	B: Black
S: 银色	S: Silver
L: 蓝色 (订做)	L: Blue (special order)
G: 绿色 (订做)	G: Green (special order)
R: 红色 (订做)	R: Red (special order)

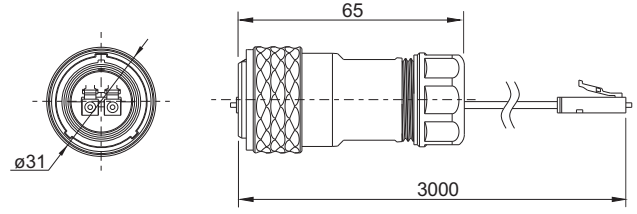

★ 线材长度可以定制
Wire length can be customized



LC 光纤对接电缆插座
与 SA2410 相配
Rreceptacle with LC adapter
Mate with SA2410

SA2411/SLC

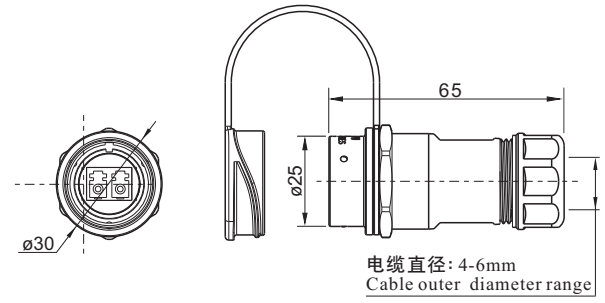

LC 光纤后螺母插座
与 SA2410 相配
Rear-nut mount receptacle
with LC adapter
Mate with SA2410

SA2412/SLC

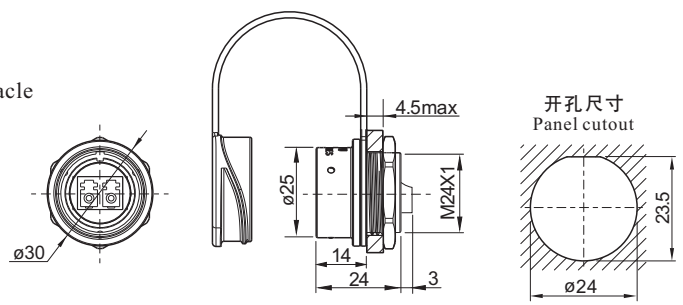

LC 光纤方形法兰插座
与 SA2410 相配
Square flange receptacle
with LC adapter
Mate with SA2410

SA2413/SLC

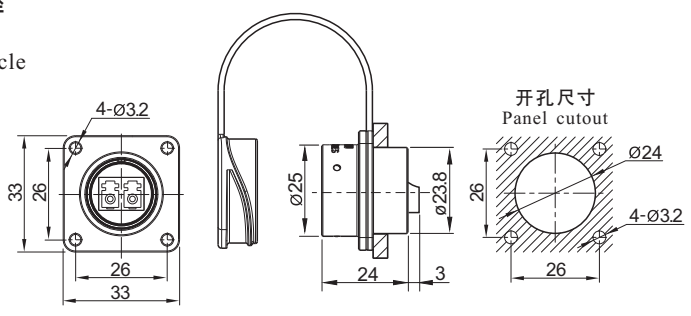

SA24 Series



SA24
信号数据

03



RJ45电缆插头
与 SA2411、SA2412、SA2413 相配
RJ45 Plug
Mate with SA2411, SA2412, SA2413

SA2410/PRJ45

颜色:	Colour:
B:黑色	B: Black
S:银色	S: Silver
L:蓝色 (订做)	L: Blue (special order)
G:绿色 (订做)	G: Green (special order)
R:红色 (订做)	R: Red (special order)

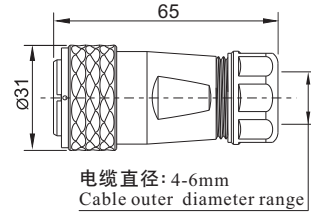
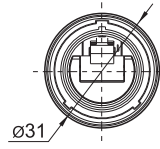

电缆直径: 4-6mm
Cable outer diameter range



RJ45对接电缆插座
与 SA2410 相配
RJ45 Receptacle
Mate with SA2410

SA2411/SRJ45

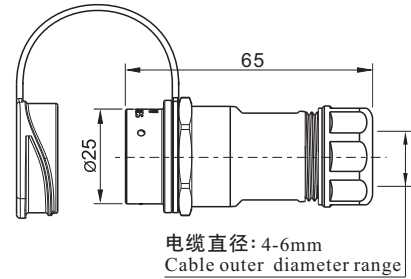
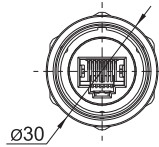

电缆直径: 4-6mm
Cable outer diameter range



RJ45后螺母插座
与 SA2410 相配
RJ45 Rear-nut mount receptacle
Mate with SA2410

SA2412/SRJ45

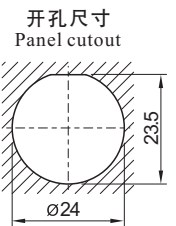
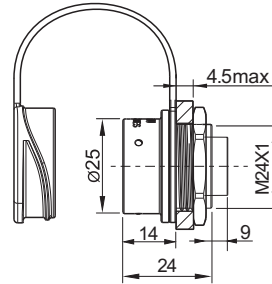
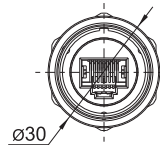

开孔尺寸
Panel cutout



RJ45方形法兰插座
与 SA2410 相配
RJ45 Square flange receptacle
Mate with SA2410

SA2413/SRJ45

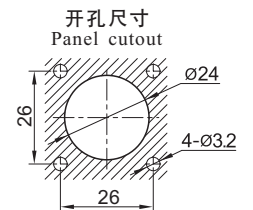
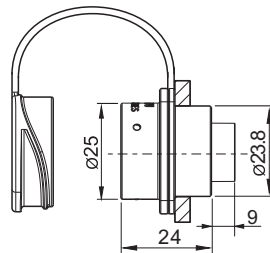
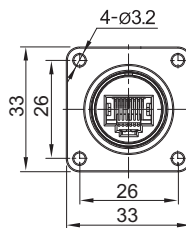

开孔尺寸
Panel cutout



SA24 Series



USB3.0电缆插头
与 SA2411、SA2412、SA2413
USB3.0 Plug
Mate with SA2411, SA2412, SA2413

SA2410/PUSB3.0

线长:	Wire length:
0.5m	0.5m
1.0m	1.0m
1.5m	1.5m
2.0m	2.0m
3.0m	3.0m

颜色:	Colour:
B:黑色	B: Black
S:银色	S: Silver
L:蓝色 (订做)	L: Blue (special order)
G:绿色 (订做)	G: Green (special order)
R:红色 (订做)	R: Red (special order)

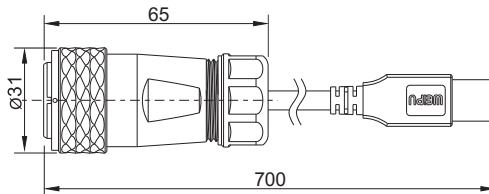
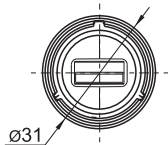

★线材长度可以定制
Wire length can be customized



USB3.0对接电缆插座
与SA2410相配
USB3.0 Receptacle
Mate with SA2410

SA2411/SUSB3.0

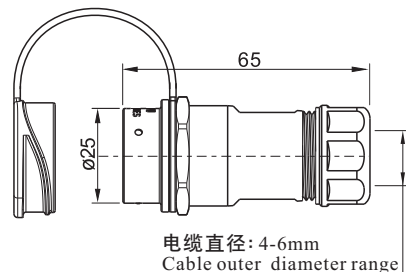
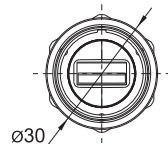

电缆直径: 4-6mm
Cable outer diameter range



USB3.0后螺母插座
与SA2410相配
USB3.0 Rear-nut mount receptacle
Mate with SA2410

SA2412/SUSB3.0

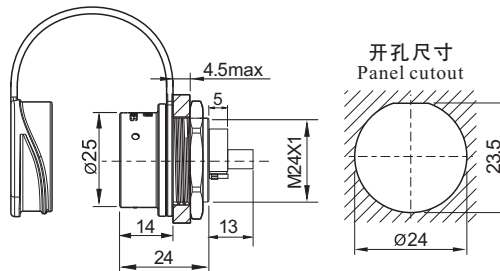
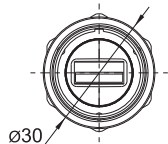

开孔尺寸
Panel cutout



USB3.0方形法兰插座
与SA2410相配
USB3.0 Square flange receptacle
Mate with SA2410

SA2413/SUSB3.0

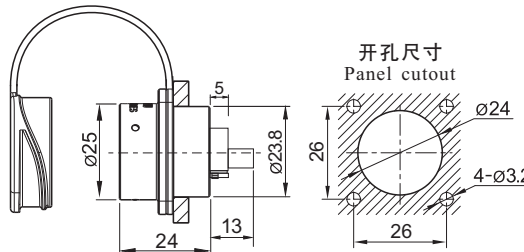
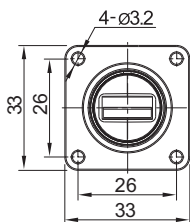

开孔尺寸
Panel cutout



HDMI2.0电缆插头
与 SA2411、SA2412、SA2413 相配
HDMI2.0 Plug
Mate with SA2411, SA2412, SA2413

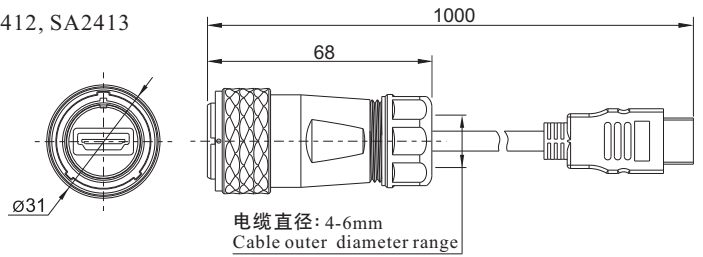

SA2410/PHDMI2.0

线长:	Wire length:
0.5m	0.5m
1.0m	1.0m
1.5m	1.5m
2.0m	2.0m
3.0m	3.0m

颜色:	Colour:
B:黑色	B: Black
S:银色	S: Silver
L:蓝色 (订做)	L: Blue (special order)
G:绿色 (订做)	G: Green (special order)
R:红色 (订做)	R: Red (special order)

★线材长度可以定制
Wire length can be customized



HDMI2.0对接电缆插座
与SA2410相配
HDMI2.0 Receptacle
Mate with SA2410

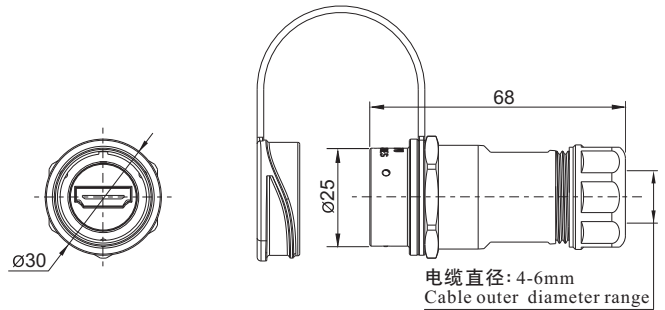

SA2411/SHDMI2.0



HDMI2.0后螺母插座
与SA2410相配
HDMI2.0 Rear-nut mount receptacle
Mate with SA2410

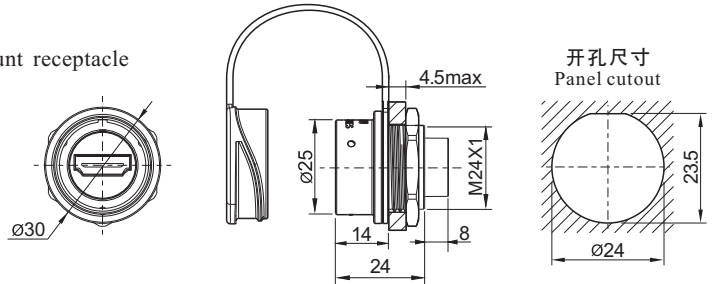

SA2412/SHDMI2.0



HDMI2.0方形法兰插座
与SA2410相配
HDMI2.0 Square flange receptacle
Mate with SA2410

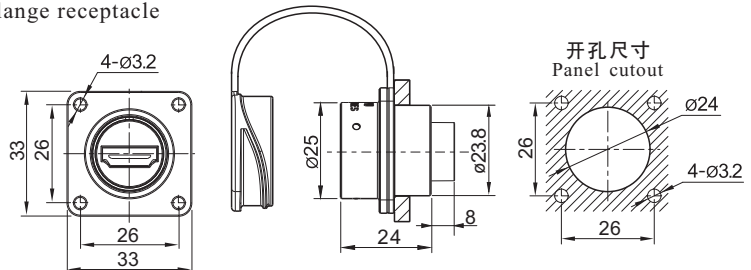

SA2413/SHDMI2.0