

威浦电器总代理：荷泽友创电气。正品保证，假一赔十。王经理：15865833585。微信15865833585



威浦电器总代理：荷泽友创电气。正品保证，假一赔十。王经理：15865833585。微信15865833585

## 公司简介

Connect to put the new  
realm of technique

威浦电器成立于1996年，多年专注于工业连接器的研发与制造，是“全国电器附件标准化技术委员会”组织机构的成员之一，是国标GB/T11918的起草单位之一。

WEIPU was established in 1996, specialize in R&D and manufacturing the industrial connectors, we are the member of “National Electrical Appliances Standardization Technical Committees” and one of the members to draft the national standard for industrial connectors GB/T11918.



威浦工厂实景  
Factory premises

威浦局部厂区  
Workshop building





IP67

SF Series

- SF 系列 IP67
- SF Series IP67
- 推入式快速锁紧
- Push-pull coupling

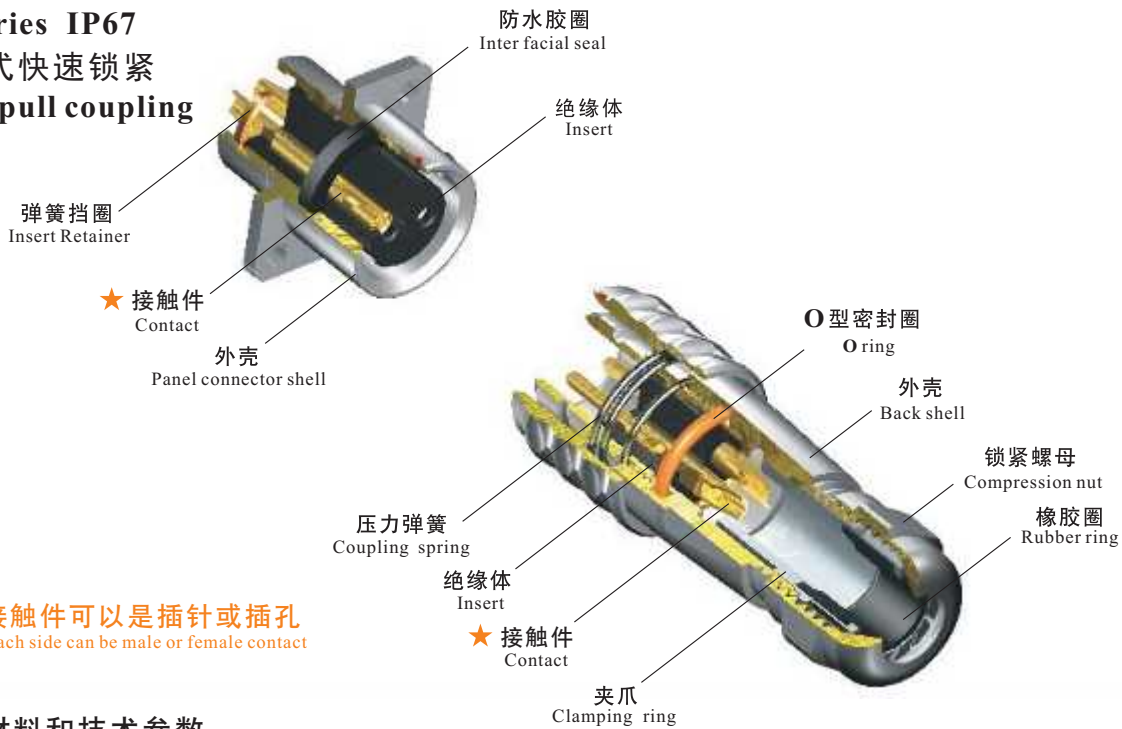

★ 接触件可以是插针或插孔  
Each side can be male or female contact

### 材料和技术参数 Material and spec

接插方式	Coupling	推入式快速锁紧	Push-pull
外壳材料	Shell material	铜镀铬	Brass with chrome plating
绝缘体	Insert material	热塑性塑料PPS 耐高温 260℃	PPS max temperature 260 °C
接触件材料	Contact material	铜镀金	Brass with gold plating
接线方式	Termination	焊接: SF6, SF8, SF10, SF12, SF16, SF20 压接: SF16, SF20 螺丝压接: SF20 (Ø2.5mm插针)	Solder: SF6, SF8, SF10, SF12, SF16, SF20 Crimp: SF16, SF20 Screw: SF20 (Ø2.5mm contact)
电缆直径	Cable outer diameter range	SF6: I: 2-3mm, II: 3-4mm(不标) SF8: I: 3-4mm, II: 4-5mm(不标) SF10: I: 3-4mm, II: 4-6.5mm(不标) SF12: I: 4-6.5mm(不标), II: 5-8mm	SF16 I: 5-8mm(不标), II: 8-12mm SF20 I: 5-9mm, II: 8-12mm(不标)
防护等级	IP rating	IP67	
接插次数	Mating cycle	500	
温度范围	Temperature range	-40℃ ~ +85℃	
绝缘电阻	Insulation resistance	2000MΩ	



SF  
6

SF6 Series



电缆插头  
与SF611B、SF612B、SF615B相配

Cable connector  
Mate with SF611B, SF612B,  
SF615B

SF610B/P

SF610B/S

插针 Male contact

电缆直径: Cable outer diameter range

I: 2-3mm, II: 3-4mm(不标)

芯数 Number of contact

插孔 Female contact

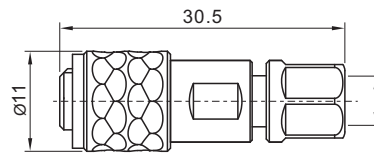
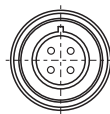

电缆直径: I: 2-3mm, II: 3-4mm(不标)  
Cable outer diameter range



电缆对接插座  
与SF610B相配

In-line cable connector  
Mate with SF610B

SF611B/P

SF611B/S

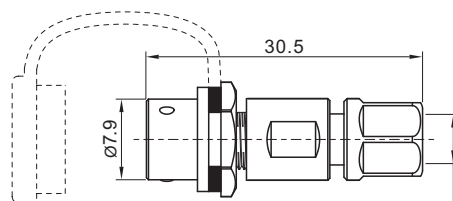
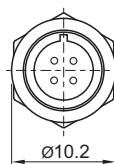

电缆直径: I: 2-3mm, II: 3-4mm(不标)  
Cable outer diameter range



后螺母插座  
与SF610B相配

Rear-nut mount  
Mate with SF610B

SF612B/P

SF612B/S

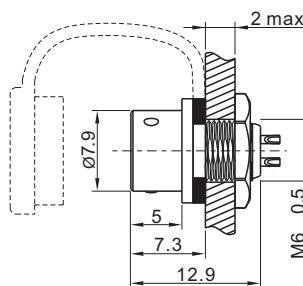
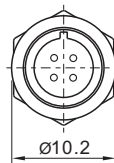

开孔尺寸  
Panel cutout

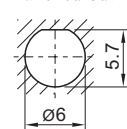

前螺母插座  
与SF610B相配

Front-nut mount  
Mate with SF610B

SF615B/P

SF615B/S

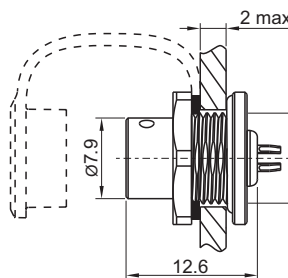
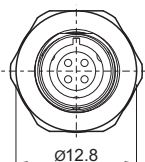

开孔尺寸  
Panel cutout

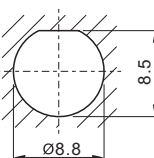

焊接芯件参数 Solder contact spec

芯数 Number of contact	2	3	4	5
公端绝缘体正面图 Male contact face view				
额定电流(A) Rated current(A)	3	3	3	3
接触件直径(mm) Contact diameter(mm)	Ø0.6 2	Ø0.6 3	Ø0.6 4	Ø0.6 5
工作电压(AC.V) Rated voltage(AC.V)	30	30	30	30
耐压(AC.V) 1 min Test voltage(AC.V) 1 min	500	500	500	500
接触电阻(mΩ) Contact resistance(mΩ)	10	10	10	10
线规(mm²/AWG) Wire size(mm²/AWG)	≤0.5/20	≤0.5/20	≤0.5/20	≤0.5/20

SF8 Series



电缆插头  
与SF811B、SF812B、SF815B相配

Cable connector  
Mate with SF811B, SF812B,  
SF815B

SF810B/P — SF810B/S

插针 Male contact

电缆直径: Cable outer diameter range  
I: 3-4mm, II: 4-5mm(不标)  
芯数 Number of contact  
插孔 Female contact

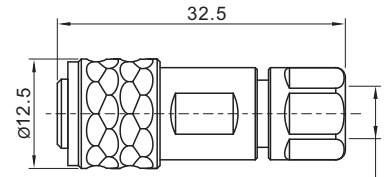
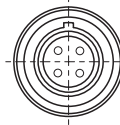

电缆直径: I: 3-4mm, II: 4-5mm(不标)  
Cable outer diameter range



电缆对接插座  
与SF810B相配

In-line cable connector  
Mate with SF810B

SF811B/P — SF811B/S

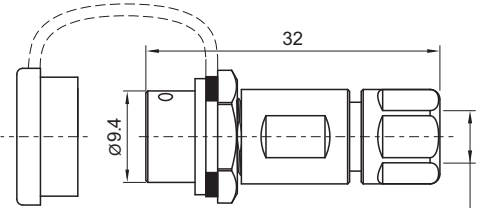
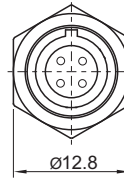

电缆直径: I: 3-4mm, II: 4-5mm(不标)  
Cable outer diameter range



后螺母插座  
与SF810B相配

Rear-nut mount  
Mate with SF810B

SF812B/P — SF812B/S

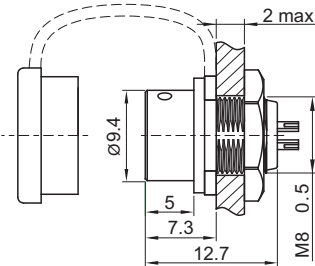
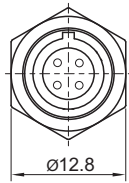

开孔尺寸  
Panel cutout

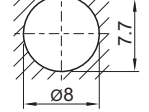

前螺母插座  
与SF810B相配

Front-nut mount  
Mate with SF810B

SF815B/P — SF815B/S

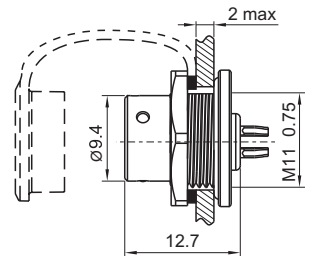
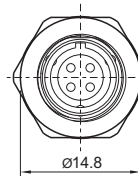

开孔尺寸  
Panel cutout



焊接芯件参数 Solder contact spec

芯数 Number of contact	2	3	4	6	8
公端绝缘体正面图 Male contact face view					
额定电流 (A) Rated current (A)	5	5	3	3	3
接触件直径(mm) Contact diameter(mm)	Ø1×2	Ø1×3	Ø0.6×4	Ø0.6×6	Ø0.6×8
工作电压 (AC.V) Rated voltage (AC.V)	125	125	30	30	30
耐压 (AC.V) 1 min Test voltage(AC.V) 1 min	1000	1000	500	500	500
接触电阻 (mΩ) Contact resistance(mΩ)	5	5	10	10	10
线规 (mm <sup>2</sup> /AWG) Wire size (mm <sup>2</sup> /AWG)	≤0.75/18	≤0.75/18	≤0.5/20	≤0.5/20	≤0.5/20

## SF10 Series



**电缆插头**  
与SF1011、SF1012、SF1015相配

Cable connector  
Mate with SF1011, SF1012,  
SF1015

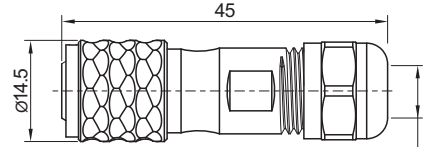
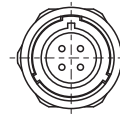

SF1010 / P — SF1010 / S —  
插针 Male contact

电缆直径: Cable outer diameter range  
I: 3-4mm, II: 4-6.5mm (不标)  
芯数 Number of contact  
插孔 Female contact

电缆直径: I: 3-4mm, II: 4-6.5mm(不标)  
Cable outer diameter range



**电缆对接插座**  
与SF1010相配

In-line cable connector  
Mate with SF1010

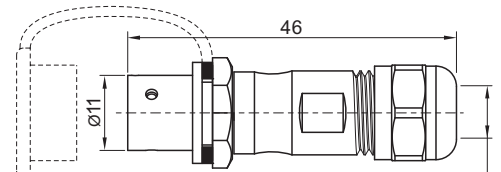
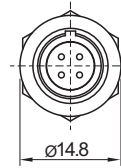

SF1011 / P — SF1011 / S —

电缆直径: I: 3-4mm, II: 4-6.5mm(不标)  
Cable outer diameter range



**后螺母插座**  
与SF1010相配

Rear-nut mount  
Mate with SF1010

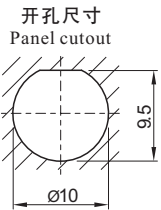
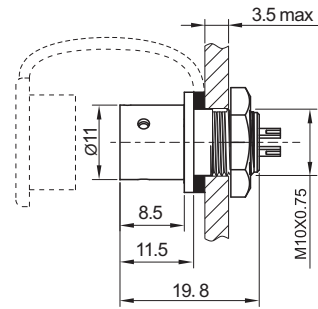
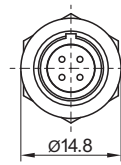

SF1012 / P — SF1012 / S —



**前螺母插座**  
与SF1010相配

Front-nut mount  
Mate with SF1010

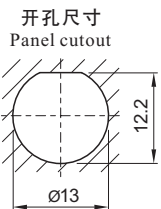
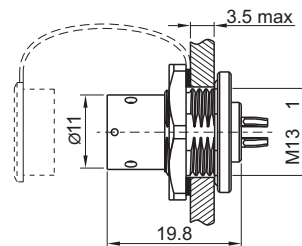

SF1015 / P — SF1015 / S —

## 焊接芯件参数 Solder contact spec

芯数 Number of contact	2	3	4	5
公端绝缘体正面图 Male contact face view				
额定电流 (A) Rated current (A)	5	5	3	3
接触件直径(mm) Contact diameter(mm)	Ø1×2	Ø1×3	Ø0.7×4	Ø0.7×5
工作电压 (AC.V) Rated voltage (AC.V)	180	180	125	125
耐压 (AC.V) 1 min Test voltage(AC.V) 1 min	1000	1000	1000	1000
接触电阻 (mΩ) Contact resistance(mΩ)	5	5	10	10
线规 (mm²/AWG) Wire size (mm²/AWG)	≤0.75/18	≤0.75/18	≤0.5/20	≤0.5/20

SF12 Series

SF12



**电缆插头**  
与SF1211、SF1212、SF1213、SF1215相配  
Cable connector  
Mate with SF1211, SF1212, SF1213, SF1215

SF1210 / P — SF1210 / S —  
插针 Male contact

电缆外径 Cable outer diameter  
I: 4-6.5mm (不标), II: 5-8mm  
芯数 Number of contact  
插孔 Female contact

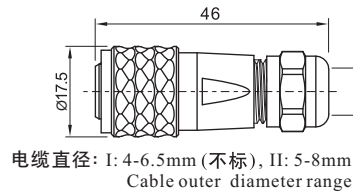
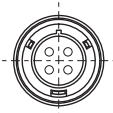

**弯式电缆插头**  
与SF1211、SF1212、SF1213、SF1215相配  
Angled cable connector  
Mate with SF1211, SF1212, SF1213, SF1215

SF1214 / P — II SF1214 / S — II

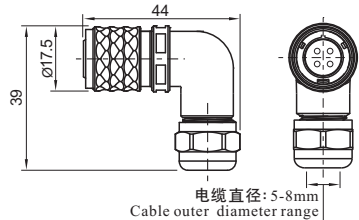

**电缆对接插座**  
与SF1210、SF1214相配  
In-line cable connector  
Mate with SF1210, SF1214

SF1211 / P — SF1211 / S —

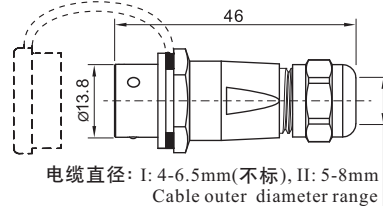
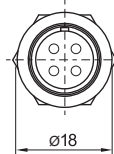

**后螺母插座**  
与SF1210、SF1214相配  
Rear-nut mount  
Mate with SF1210, SF1214

SF1212 / P — SF1212 / S —

芯数 Number of contact

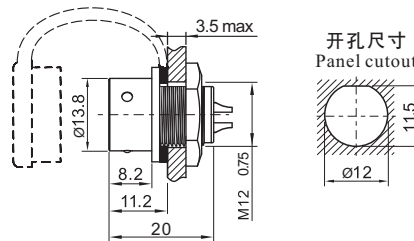
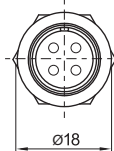

**方形法兰插座**  
与SF1210、SF1214相配  
Square flange  
Mate with SF1210, SF1214

SF1213 / P — SF1213 / S —

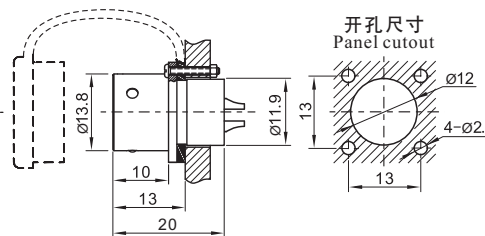
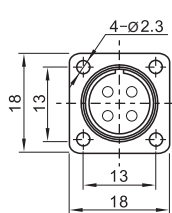

**前螺母插座**  
与SF1210、SF1214相配  
Front-nut mount  
Mate with SF1210, SF1214

SF1215 / P — SF1215 / S —

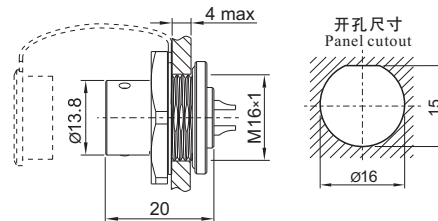
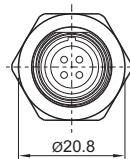

焊接芯件参数 Solder contact spec

芯数 Number of contact	2	3	4	5	6	7	9
公端绝缘体正面图 Male contact face view							
额定电流 (A) Rated current (A)	13	13	5	5	5	5	3
接触件直径(mm) Contact diameter(mm)	Ø1.6X2	Ø1.6X3	Ø1X4	Ø1X5	Ø1X6	Ø1X7	Ø0.7X9
工作电压 (AC.V) Rated voltage (AC.V)	250	250	200	180	125	125	125
耐压 (AC.V) 1 min Test voltage(AC.V) 1 min	1500	1500	1500	1000	1000	1000	1000
接触电阻 (mΩ) Contact resistance (mΩ)	2.5	2.5	5	5	5	5	10
线规 (mm <sup>2</sup> /AWG) Wire size (mm <sup>2</sup> /AWG)	≤2/14	≤2/14	≤0.75/18	≤0.75/18	≤0.75/18	≤0.75/18	≤0.5/20

## SF12 Series

SF  
12



**电缆插头**  
与SF1211、SF1212、SF1213相配  
Cable connector  
Mate with SF1211, SF1212,  
SF1213

SF1210 / P — SF1210 / S —  
插针 Male contact

(U): LISTED  
芯数 Number of contact  
插孔 Female contact

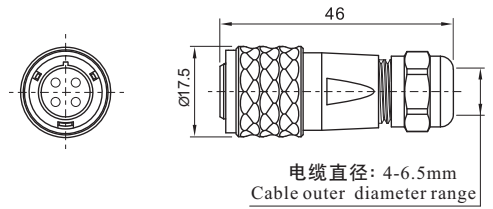

**弯式电缆插头**  
与SF1211、SF1212、SF1213相配  
Angled cable connector  
Mate with SF1211, SF1212, SF1213

SF1214 / P — II — SF1214 / S — II —

(U): LISTED

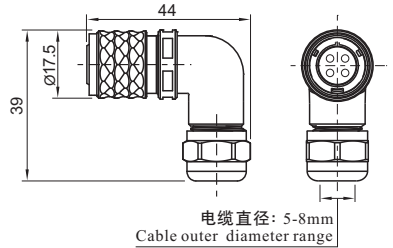

**电缆对接插座**  
与SF1210、SF1214相配  
In-line cable connector  
Mate with SF1210, SF1214

SF1211 / P — SF1211 / S —

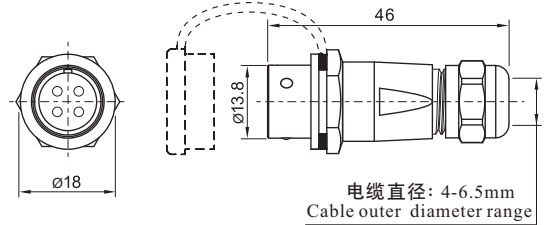

**后螺母插座**  
与SF1210、SF1214相配  
Rear-nut mount  
Mate with SF1210,  
SF1214

SF1212 / P — SF1212 / S —

(U): LISTED  
芯数 Number of contact

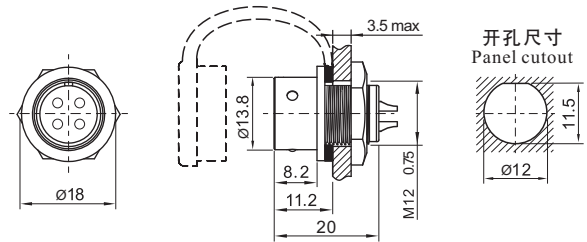

**方方法兰插座**  
与SF1210、  
SF1214相配  
Square flange  
Mate with SF1210,  
SF1214

SF1213 / P — SF1213 / S —

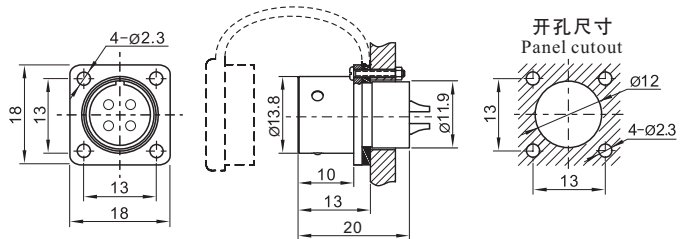

## 焊接芯件参数 Solder contact spec

芯数 Number of contact	4	5	6	7
公端绝缘体正面图 Male contact face view				
额定电流 (A) Rated current (A)	5	5	5	5
接触件直径(mm) Contact diameter(mm)	Ø1X4	Ø1X5	Ø1X6	Ø1X7
工作电压 (AC.V) Rated voltage (AC.V)	300	300	300	300
耐压 (AC.V) 1 min Test voltage(AC.V) 1 min	1500	1000	1000	1000
接触电阻 (mΩ) Contact resistance (mΩ)	5	5	5	5
线规 (AWG) Wire size (AWG)	18	18	18	18



# SF16 Series

SF  
16



**电缆插头**  
与SF1611、SF1612、SF1613、SF1615相配

Cable connector  
Mate with SF1611, SF1612, SF1613, SF1615

SF1610 / P --- SF1610 / S  
插针 Male contact

1: 焊接(不标), 3: 压接  
1: solder, 3: crimp  
电缆外径 Cable outer diameter  
I: 5-8mm (不标), II: 8-12mm  
芯数 Number of contact  
插孔 Female contact

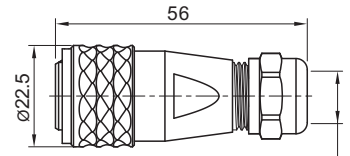
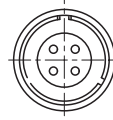

电缆直径: I: 5-8mm (不标), II: 8-12mm  
Cable outer diameter range



**电缆对接插座**  
与SF1610相配

In-line cable connector  
Mate with SF1610

SF1611 / P --- SF1611 / S ---

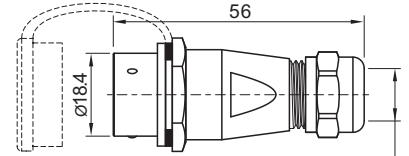

电缆直径: I: 5-8mm (不标), II: 8-12mm  
Cable outer diameter range



**后螺母插座**  
与SF1610相配

Rear-nut mount  
Mate with SF1610

SF1612 / P --- SF1612 / S ---

1: 焊接(不标), 3: 压接  
1: solder, 3: crimp  
芯数 Number of contact

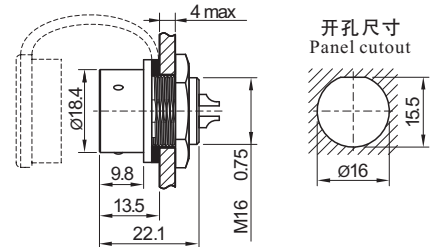
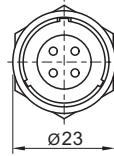

开孔尺寸  
Panel cutout



**方方法兰插座**  
与SF1610相配

Square flange  
Mate with SF1610

SF1613 / P --- SF1613 / S ---

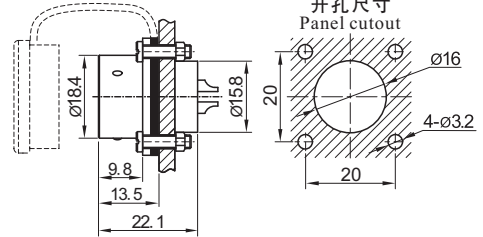
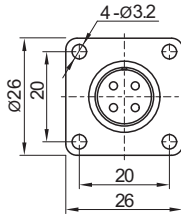

开孔尺寸  
Panel cutout



**前螺母插座**  
与SF1610相配

Front-nut mount  
Mate with SF1610

SF1615 / P --- SF1615 / S ---

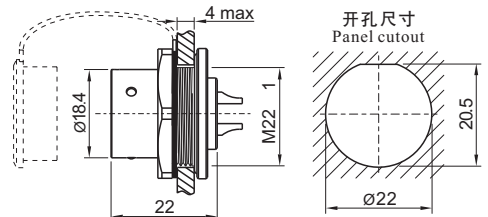
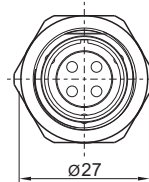

开孔尺寸  
Panel cutout

## 焊接芯件参数 Solder contact spec

★压接芯件参数表在P20页>> Crimp contact spec see P20

芯数 Number of contact	2	3	4	2B	3B	4B	5	7	9	10
公端绝缘体正面图 Male contact face view										
额定电流 (A) Rated current (A)	10	10	5	15	15	15	5	5	5	5
接触件直径(mm) Contact diameter(mm)	ø1.5X2	ø1.5X3	ø1X4	ø2X2	ø2X3	ø2X4	ø1X5	ø1X7	ø1X9	ø1X10
工作电压 (AC.V) Rated voltage (AC.V)	500	500	500	500	500	500	500	400	400	400
耐压 (AC.V) 1 min Test voltage(AC.V) 1 min	1500	1500	1500	1500	1500	1500	1500	1200	1200	1200
接触电阻 (mΩ) Contact resistance (mΩ)	2.5	2.5	5	2.5	2.5	2.5	5	5	5	5
线规 (mm²/AWG) Wire size (mm²/AWG)	≤2/14	≤2/14	≤0.75/18	≤2/14	≤2/14	≤2/14	≤0.75/18	≤0.75/18	≤0.75/18	≤0.75/18

# SF20 Series

**SF  
20**



SF2010/P --- SF2010/S  
插针 Male contact

**电缆插头**  
与SF2011、SF2012、SF2013、SF2015相配

Cable connector  
Mate with SF2011, SF2012,  
SF2013, SF2015

1: 焊接(不标), 2: 螺丝压接, 3: 压接  
1: solder, 2: screw, 3: crimp  
电缆直径: Cable outer diameter range  
I: 5-9mm, II: 8-12mm (不标)  
芯数 Number of contact  
插孔 Female contact

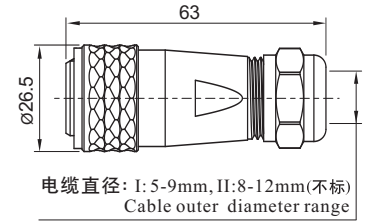
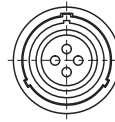

SF2011/P --- SF2011/S

**电缆对接插座**  
与SF2010相配  
In-line cable connector  
Mate with SF2010

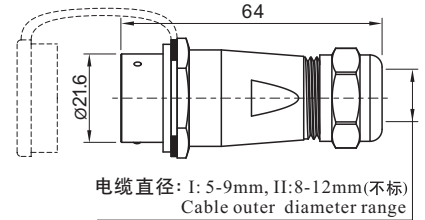

SF2012/P --- SF2012/S

**后螺母插座**  
与SF2010相配  
Rear-nut mount  
Mate with SF2010

1: 焊接(不标), 2: 螺丝压接, 3: 压接  
1: solder, 2: screw, 3: crimp  
芯数 Number of contact

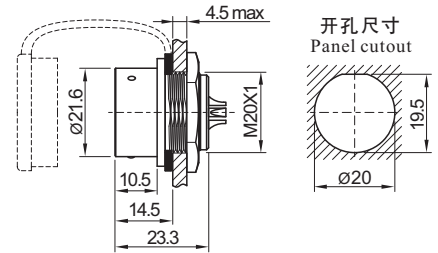
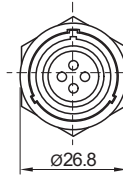

SF2013/P --- SF2013/S

**方方法兰插座**  
与SF2010相配  
Square flange  
Mate with SF2010

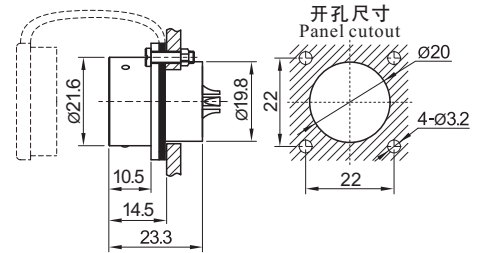
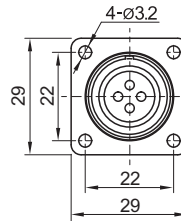

SF2015/P --- SF2015/S

**前螺母插座**  
与SF2010相配  
Front-nut mount  
Mate with SF2010

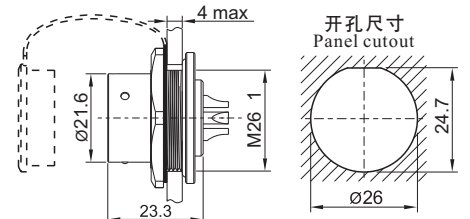
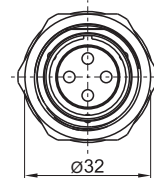

## 焊接芯件参数 Solder contact spec

★压接芯件参数表在P20页>>  
Crimp contact spec see P20

★螺丝压接芯件参数表在P21页>>  
Screw contact spec see P21

芯数 Number of contact	2	3	4	5	6	6B	7	8	9	12	15
公端绝缘体正面图 Male contact face view											
额定电流(A) Rated current (A)	25	25	25	10	25 5	30 5	10	10	5	5	5
接触件直径(mm) Contact diameter(mm)	Ø2.5X2	Ø2.5X3	Ø2.5X4	Ø1.5X5	Ø2.5X4 Ø1X2	Ø3X2 Ø1X4	Ø1.5X7	Ø1.5X8	Ø1X9	Ø1X12	Ø1X15
工作电压(AC.V) Rated voltage (AC.V)	500	500	500	500	500	500	500	500	400	400	400
耐压(AC.V) 1 min Test voltage(AC.V) 1 min	1500	1500	1500	1500	1500	1500	1500	1500	1200	1200	1200
接触电阻(mΩ) Contact resistance (mΩ)	1	1	1	2.5	1 5	1 5	2.5	2.5	5	5	5
接线方式 Termination	焊接/螺丝压接 solder / screw	焊接/螺丝压接 solder / screw	焊接/螺丝压接 solder / screw	焊接 solder	焊接 solder	焊接 solder	焊接 solder	焊接 solder	焊接 solder	焊接 solder	焊接 solder
焊接线规(mm²/AWG) Wire size for solder(mm² / AWG)	≤4/11	≤4/11	≤4/11	≤2/14	≤4/11 ≤0.75/18	≤4/11 ≤0.75/18	≤2/14	≤2/14	≤0.75/18	≤0.75/18	≤0.75/18
螺丝压接线规(mm²/AWG) Wire size for screw termination(mm²/AWG)	≤1.5/15	≤1.5/15	≤1.5/15	/	/	/	/	/	/	/	/



IP67

ST  
12



04

- ST12 系列 IP67
- ST12 Series IP67
- 螺纹锁紧
- Threaded coupling

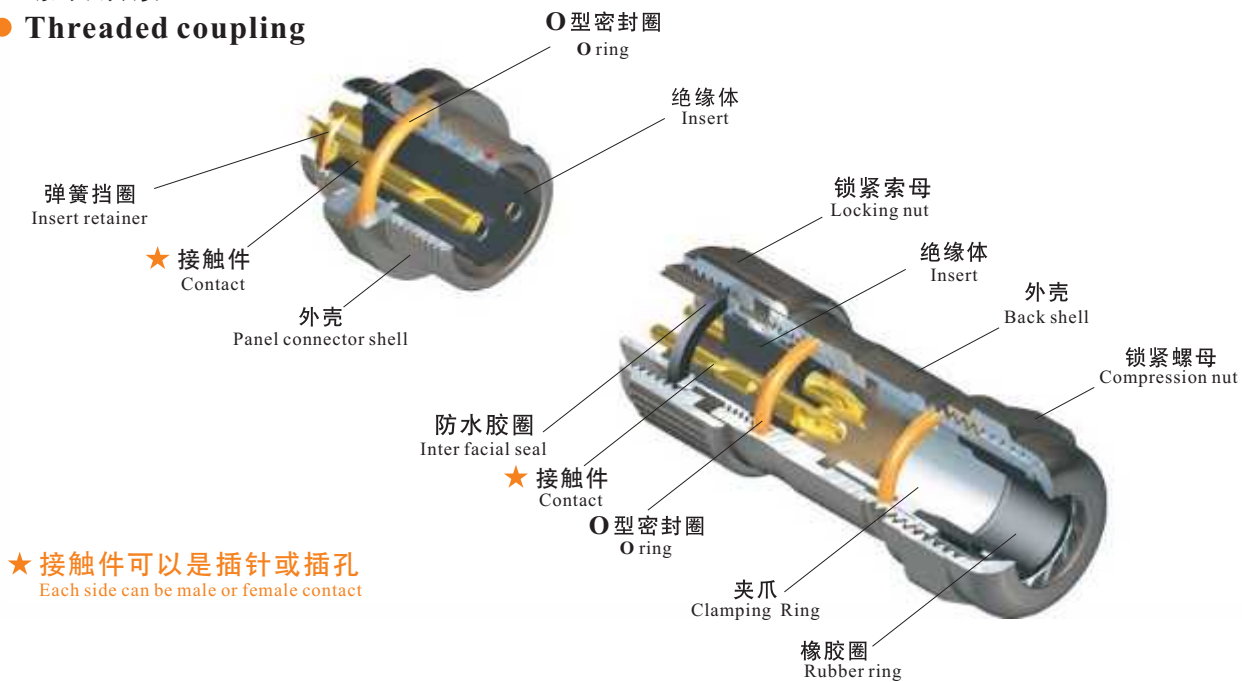

★ 接触件可以是插针或插孔  
Each side can be male or female contact

材料和技术参数  
Material and spec

接插方式	Coupling	螺纹锁紧	Threaded coupling
外壳材料	Shell material	锌基合金电镀镍	Zinc alloy with black nickel plating
绝缘体	Insert material	热塑性塑料PPS 耐高温 260℃	PPS, max temperature 260 °C
接触件材料	Contact material	铜镀金	Brass with gold plating
接线方式	Termination	焊接	Solder
电缆直径	Cable outer diameter range	5-8mm	
防护等级	IP rating	IP67	
接插次数	Mating cycle	500	
温度范围	Temperature range	-40℃~+85℃	
绝缘电阻	Insulation resistance	2000MΩ	

## ST12 Series

ST  
12



ST1210 / P— ST1210 / S—  
插针 Male contact

**电缆插头**  
与ST1211、ST1212、ST1213、  
ST1214 相配

Cable connector  
Mate with ST1211, ST1212,  
ST1213, ST1214

芯数 Number of contact  
插孔 Female contact

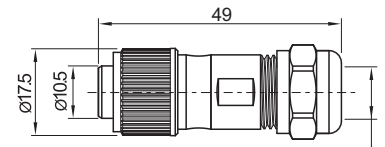
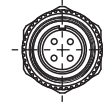

电缆直径: 5-8mm  
Cable outer diameter range



ST1211 / P— ST1211 / S—

**电缆对接插座**  
与ST1210 相配

In-line cable connector  
Mate with ST1210

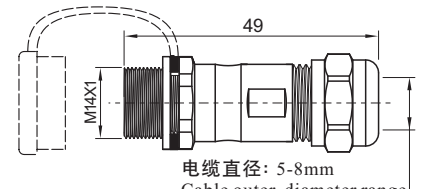
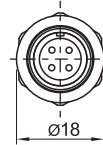

电缆直径: 5-8mm  
Cable outer diameter range



ST1212 / P— ST1212 / S—

**后螺母插座**  
与ST1210 相配

Rear-nut mount  
Mate with ST1210

芯数 Number of contact

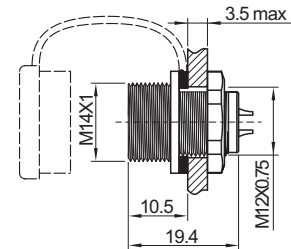
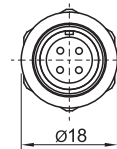

开孔尺寸  
Panel cutout

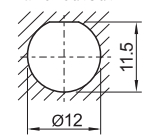

ST1213 / P— ST1213 / S—

**前螺母插座**  
与ST1210 相配

Front-nut mount  
Mate with ST1210

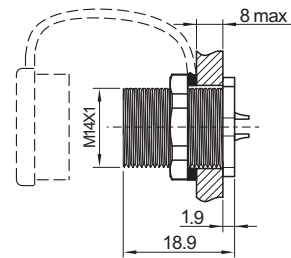
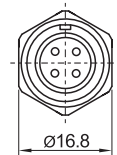

开孔尺寸  
Panel cutout

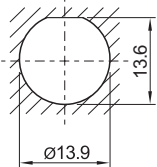

ST1214 / P— ST1214 / S—

**方形法兰插座**  
与ST1210 相配

Square flange  
Mate with ST1210

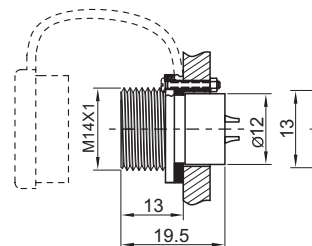
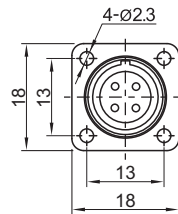

开孔尺寸  
Panel cutout

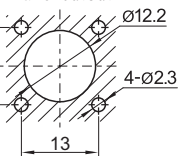

## 焊接芯件参数 Solder contact spec

芯数 Number of contact	2	3	4	5	6	7	9
公端绝缘体正面图 Male contact face view							
额定电流 (A) Rated current (A)	13	13	5	5	5	5	3
接触件直径 (mm) Contact diameter (mm)	Ø1.6X2	Ø1.6X3	Ø1X4	Ø1X5	Ø1X6	Ø1X7	Ø0.7X9
工作电压 (AC.V) Rated voltage (AC.V)	250	250	200	180	125	125	125
耐压 (AC.V) 1 min Test voltage (AC.V) 1 min	1500	1500	1500	1000	1000	1000	1000
接触电阻 (mΩ) Contact resistance (mΩ)	2.5	2.5	5	5	5	5	10
线规 (mm <sup>2</sup> /AWG) Wire size (mm <sup>2</sup> /AWG)	≤2/14	≤2/14	≤0.75/18	≤0.75/18	≤0.75/18	≤0.75/18	≤0.5/20